

電柱避暗渠

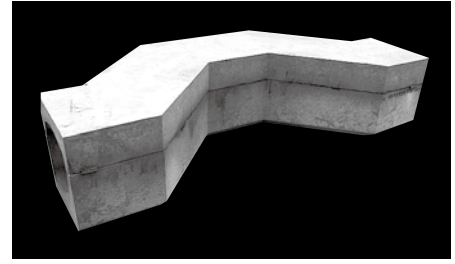

形状及び寸法 (単位: mm)

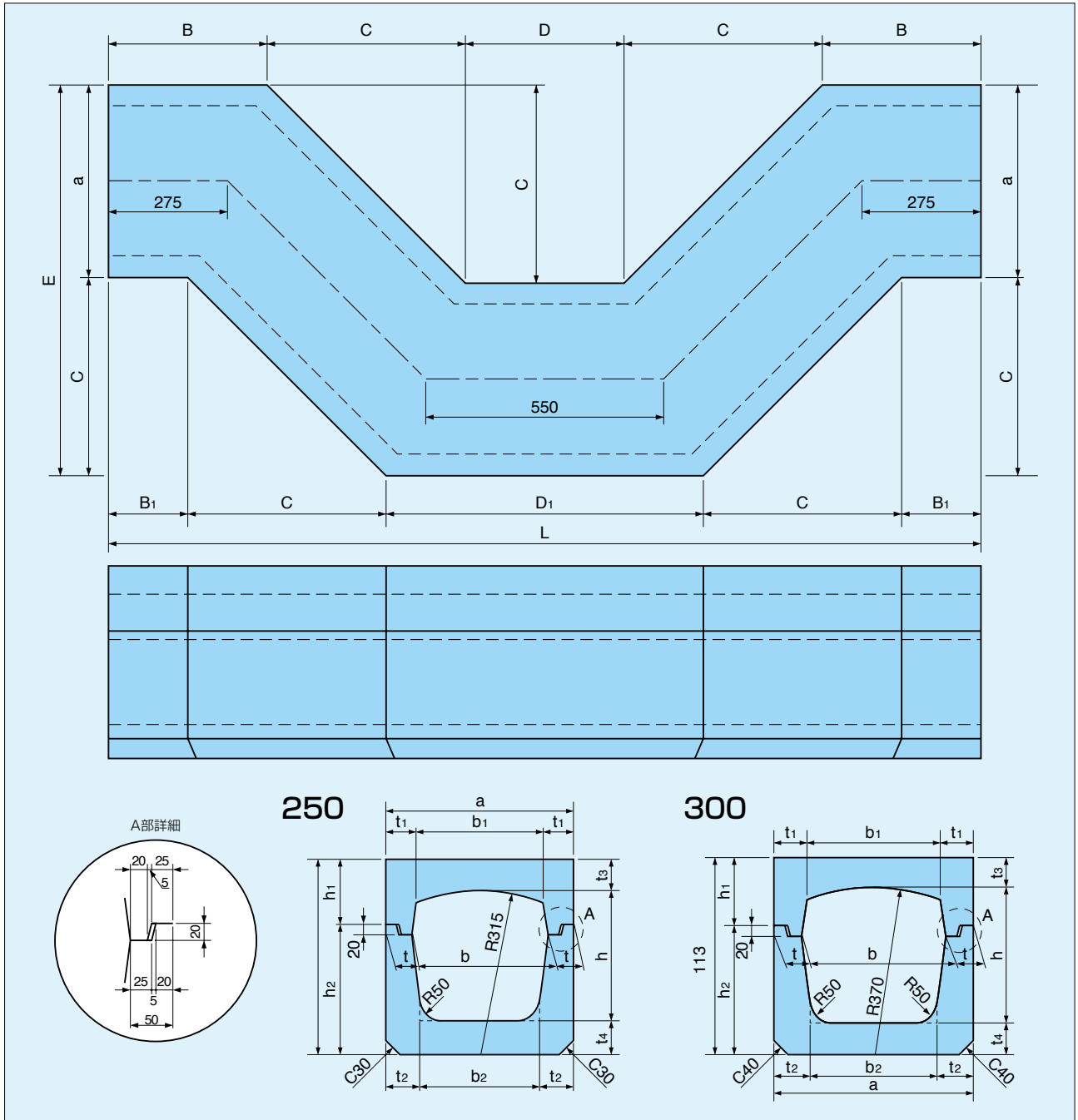

寸法表

(許容差 ± 3 mm)

種類	a	b	b ₁	b ₂	c	t	t ₁	t ₂	t ₃	t ₄	h	h ₁	h ₂	h ₃	B	B ₁	C	D	D ₁	E	L
250	360	260	244	230	30	50	58	65	60	65	250	125	250	375	350	200	450	400	700	810	2000
300	440	340	294	280	40	50	73	80	65	70	300	150	285	435	366	184	450	368	732	890	2000

電柱避暗渠 (250用)

寸法及び配筋図 (単位: mm)

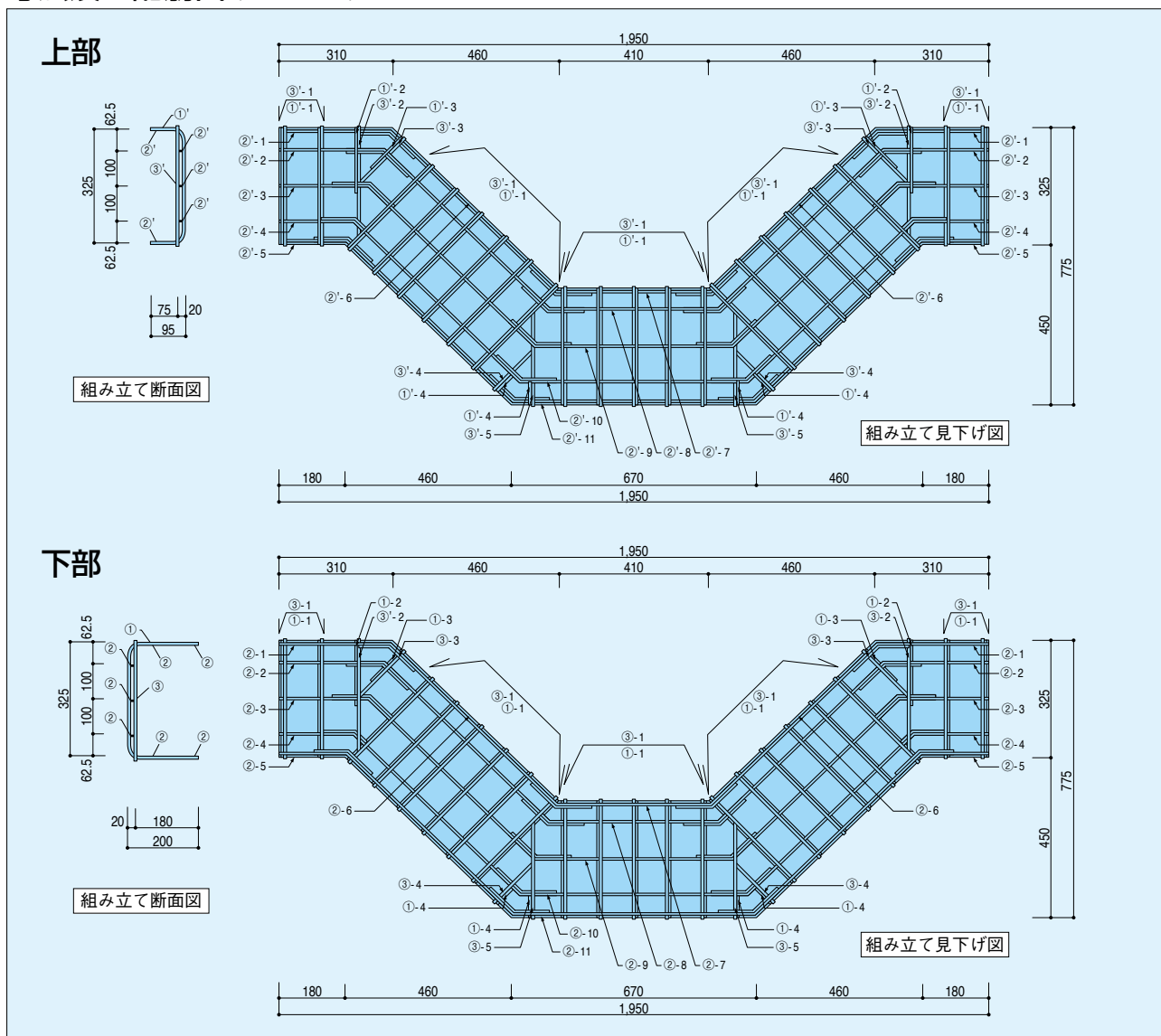

鉄筋表





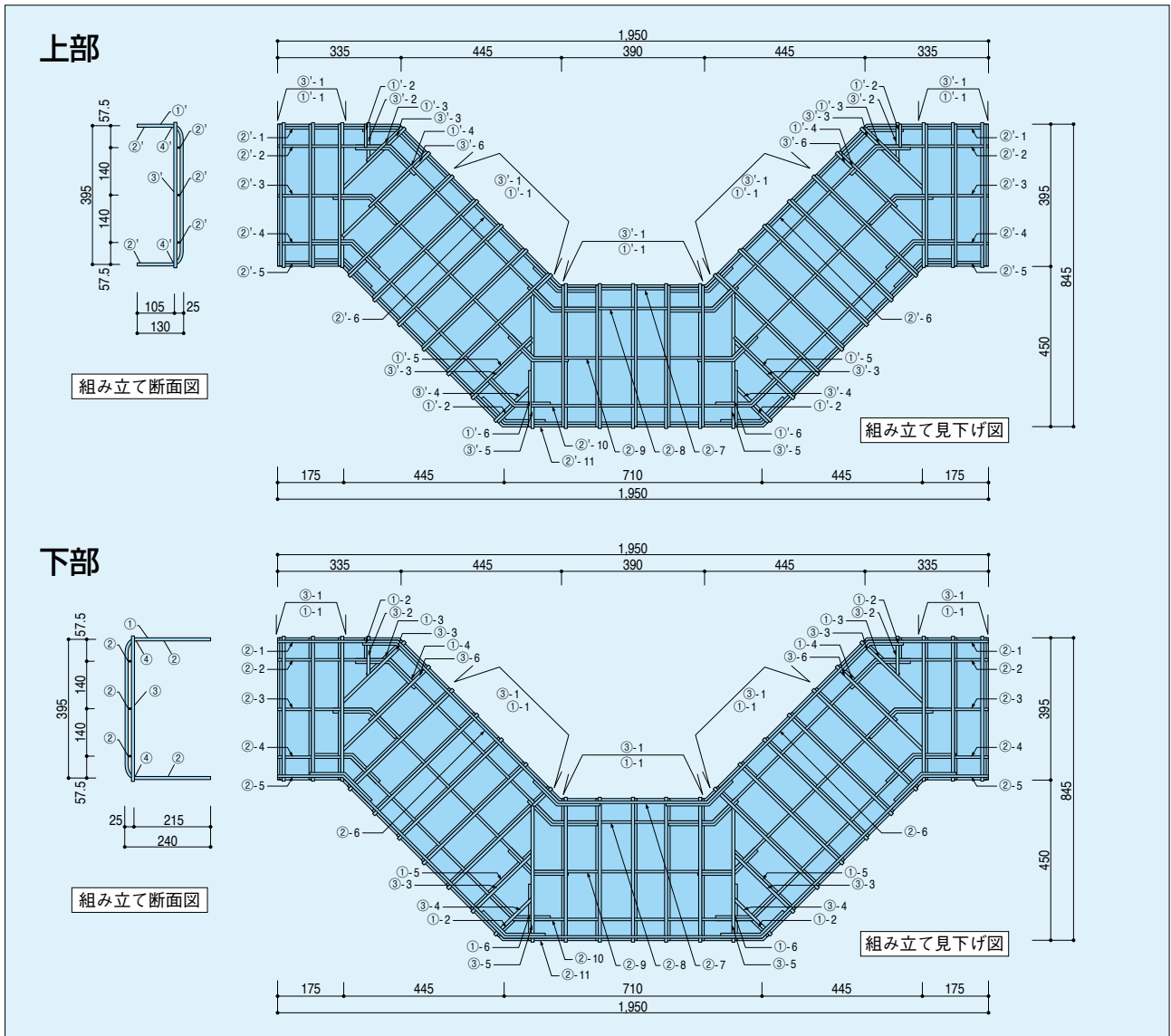

上 部	①'-1	SD6-475-21	①'-3	SD6-190-2	②'-1	SD6-285-2	③'-1	SD10-330-21
					②'-2	SD6-260-2	③'-2	SD10-295-2
下 部	①'-2	SD6-260-2	①'-4	SD6-140-4	②'-3	SD6-235-2	③'-3	SD10-170-4
					②'-4	SD6-175-2	③'-4	SD10-100-2
鉄 筋	①-1	SD6-685-21	①-3	SD6-295-2	②'-5	SD6-160-2	③'-5	SD10-245-2
					②'-6	SD6-620-10		
鉄 筋	①-2	SD6-365-2	①-4	SD6-245-4	②'-7	SD6-405-1	組立て筋	SD6-200-20
					②'-8	SD6-430-1		
				②'-9	SD6-500-1			
				②'-10	SD6-610-1			
				②'-11	SD6-630-1			

電柱避暗渠 (300用)

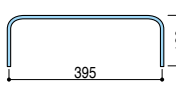
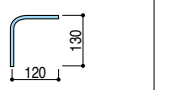
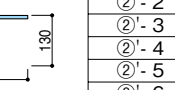
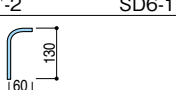
寸法及び配筋図 (単位: mm)

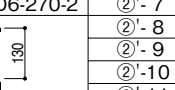

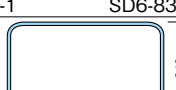
鉄筋表

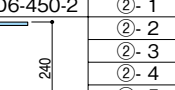
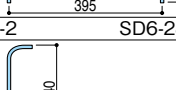
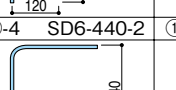
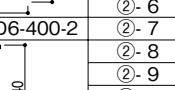
上 部	①'-1	SD6-605-21	①'-3	SD6-230-2	①'-5	SD6-340-2	②'-1	SD6-290-2	③'-1	SD10-410-21	④'
							②'-2	SD6-280-2	③'-2	SD10-110-2	SD6-330-1
							②'-3	SD6-210-2	③'-3	SD10-230-4	SD6-630-1
							②'-4	SD6-190-2	③'-4	SD10-145-2	SD6-395-1
部	①'-2	SD6-170-4	①'-4	SD6-330-2	①'-6	SD6-270-2	②'-5	SD6-180-2	③'-5	SD10-360-2	SD6-645-1
							②'-6	SD6-600-10	③'-6	SD10-320-2	SD6-310-1
							②'-7	SD6-390-1	組立て筋 SD6-200-20		SD6-180-1
							②'-8	SD6-410-1			SD6-630-1
下 部	①-1	SD6-835-21	①-3	SD6-340-2	①-5	SD6-450-2	②'-9	SD6-500-1			
							②'-10	SD6-610-1			
							②'-11	SD6-680-1			
							②'-1	SD6-290-2		③-1	SD10-410-21
部	①-2	SD6-280-4	①-4	SD6-440-2	①-6	SD6-400-2	②-2	SD6-280-2	③-2	SD10-110-2	SD6-305-1
							②-3	SD6-210-2	③-3	SD10-230-4	SD6-650-1
							②-4	SD6-190-2	③-4	SD10-145-2	SD6-395-1
							②-5	SD6-180-2	③-5	SD10-360-2	SD6-630-1
						②-6	SD6-600-10	③-6	SD10-320-2	SD6-335-1	
						②-7	SD6-390-1	組立て筋 SD6-200-20		SD6-180-1	
						②-8	SD6-410-1			SD6-640-1	
						②-9	SD6-500-1			SD6-670-1	
						②-10	SD6-610-1			SD6-630-1	
						②-11	SD6-680-1			SD6-180-1	